

# Power Fluctuations in an Isolated Wind Plant

C. Carrillo, A. E. Feijóo, J. Cidrás, *Member, IEEE*, and J. González

**Abstract**—In this paper, a wind energy converter (WEC) model for the analysis of power fluctuations at an isolated wind plant is presented. The model includes the drive train dynamics, a first-order model for the asynchronous generator, and the power controller. The influence of each element is studied, and the conditions that can provoke oscillations in the power delivered by the WEC are considered. A set of measurements carried out during the setting of an isolated wind plant in the Canary Islands (Spain) is the basis for this study. In these measurements, an oscillatory behavior has been observed when wind speed was high.

**Index Terms**—Power quality, power system dynamic stability, wind power generation.

## I. INTRODUCTION

ONE of the typical problems of wind energy converters (WECs) is the variation in their delivered power, which is the main cause of the relationship between the random nature of wind and the power. Nevertheless, added to these random variations, periodic fluctuations can appear in electrical power. The possible causes of these oscillations are: rotor turbine imbalance, blade passing in front of the tower, rotational sampling, and structural modes. Structural modes can appear because the wind excites mechanical structure eigenfrequencies that involve blades, tower, and drive train [1], [2].

WECs showing the largest variations in delivered power are those formed by an asynchronous generator coupled directly to the network. However, nowadays it is common to find wind converters where an electronic converter is used to connect the generator to the network, so the delivered power can be smoothed [3].

Networks where WECs are connected can be affected by the variability of power mentioned above (e.g., flicker is a common problem in weak grids with high wind energy penetration). This behavior is of great relevance in isolated networks, where the quality of power is closely related to the ability of wind energy converters to smooth variations of power.

The purpose of this paper is to investigate the periodic power pulsations that have been measured during the fitting of an isolated plant located in Punta Jandía (Spain). The influence of drive train and power controller on the periodic power components is to be analyzed.

Manuscript received September 23, 2002. This work was supported in part by the Ministerio de Educación y Cultura under Contract PB98-1096-CO2-01 and in part by Xunta de Galicia under Contract PGIDT00PXI32102PN.

C. Carrillo, A. E. Feijóo, and J. Cidrás are with the Departamento de Enxeñaría Eléctrica, Universidade de Vigo, Pontevedra 36200, Spain (e-mail: carrillo@uvigo.es; afeijoo@uvigo.es; jcidras@uvigo.es).

J. González is with the Departamento de Ingeniería Electrónica y Automática, Universidad de las Palmas, Las Palmas de Gran Canaria 35017, Spain (e-mail: jaime@cicei.ulpgc.es).

Digital Object Identifier 10.1109/TEC.2003.822369

## II. ISOLATED WIND PLANT AND MEASUREMENTS

The isolated wind plant studied is located in Puerto de la Cruz at the southernmost part of the Jandía Península on the Spanish island of Fuerteventura (Canary Islands) [4], [5]. The plant provides electricity to a small fishing village by means of the following elements (see Fig. 1):

- 1 × WEC Vestas 225/50 kW, pitch controlled with a two-speed asynchronous generator (six and four poles);
- 2 × diesel units with 75-kVA synchronous generators;
- 2 × flywheel included as an element of the diesel units with an inertia of 1067 kg · m<sup>2</sup>.

Other important elements closely related to the generation are the dump loads; these help to maintain the frequency of the isolated network when diesel engines are disconnected.

The maintenance and fitting of the wind plant are carried out by the Centro de Investigación de Energía y Agua – Instituto Tecnológico de Canarias (CIEA–ITC).

In order to analyze the behavior of the plant, measurements were taken at various times during the fitting of the plant. Voltage, current, power, and frequency were the electric parameters measured [3].

This paper focuses on some unstable situations that have been observed during the fitting of the plant, when the WEC was running without the diesel groups and there were high winds causing the 225-kVA generator to be connected (see Fig. 1). The WEC manufacturer corrected this behavior by adjusting the parameters of the control system. As a result, the plant is now running with more than 90% of energy produced by the WEC during the windiest months.

The results of measurements are shown in Figs. 2 and 3, where two cases can be seen.

- Unstable, with important fluctuations in power and frequency (Fig. 2).
- Stable, with small fluctuations in power and frequency with smooth variation (Fig. 3).

The spectrum of the power delivered by the WEC is shown in Fig. 4, although similar plots would be achieved with the spectrum of network frequency.

In the stable case, the frequencies that dominate the spectrum are those related to turbine rotation, which produces cyclic loads caused by wind shear, yaw, tower influence on the flow, and rotational sampling. Consequently, the multiples of turbine rotational speed, whose value is 0.71 Hz (1p), are the main components of the spectrum (1p, 2p, and 3p) [1], [2], [6].

The result is very different during the unstable situation. The component dominating the spectrum has a frequency value of 0.65 Hz, lower than 1p. This implies that the oscillation of the power delivered by the WEC and the oscillation in network frequency have their main component at this frequency [3].

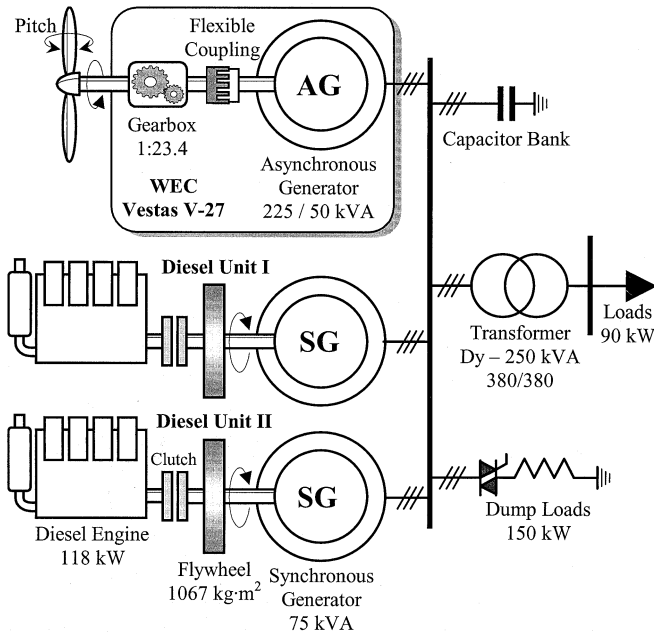

Fig. 1. Scheme of the isolated wind plant in Puerto de la Cruz (Spain).

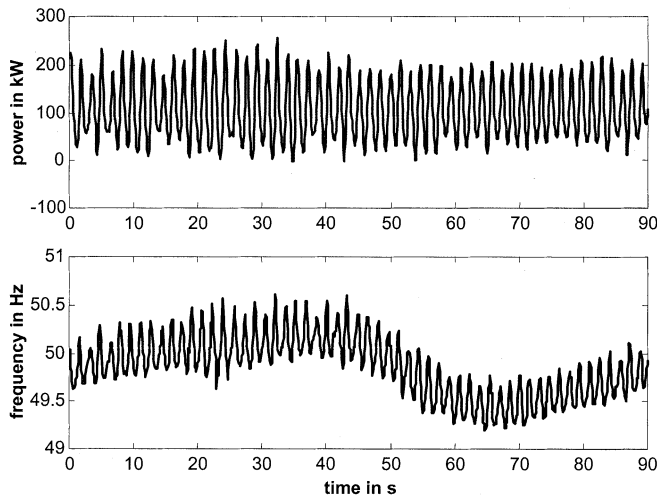

Fig. 2. Power delivered by the WEC and frequency during an unstable situation.

Frequencies, except  $p$ -multiples, in the low part of the spectrum (very low hertz) are related to mechanical modes in WECs [1], [2], [6]. In this paper, a simple WEC model is proposed to relate the drive train dynamics to the frequencies detected during the unstable situation.

### III. WEC MODELING

The unstable case shown before is dominated by a low frequency (see Fig. 4), which is related to the mechanical dynamics of the WEC. Tower, blades, hub, and low-speed shaft, gearbox, high-speed shaft, coupling between gearbox and generator electro-dynamics influence this behavior. However, in order to easily find the modes and to study the WEC dynamics, a simple model is chosen, where the drive train component is emphasized. Therefore, the model presented in this paper is formed by [7]:

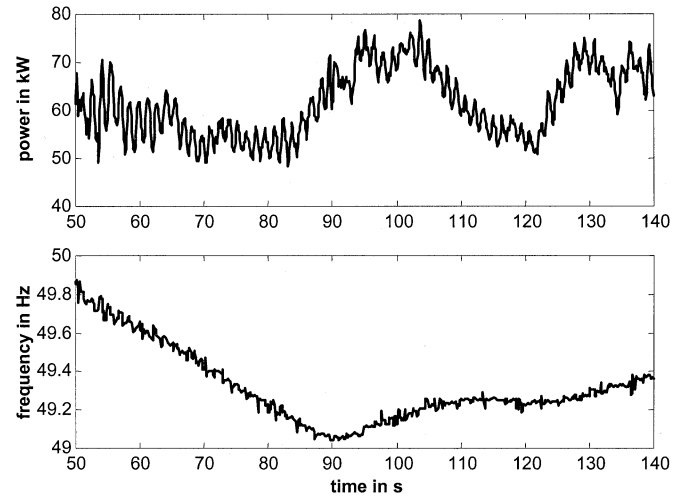

Fig. 3. Power delivered by the WEC and frequency during a stable situation.

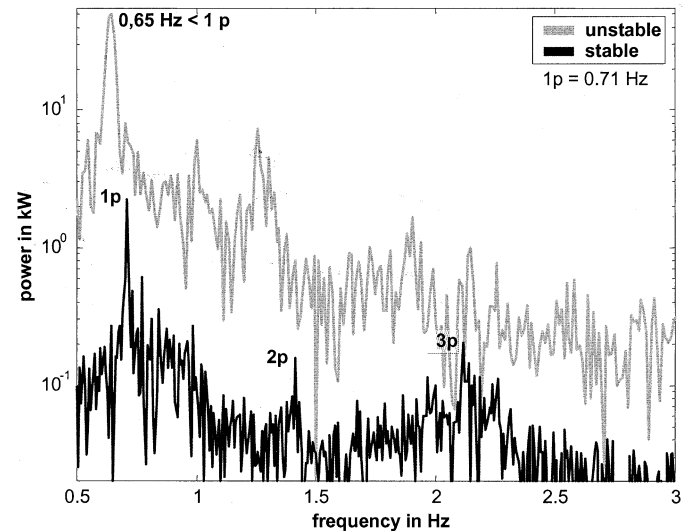

Fig. 4. Spectrum of the power delivered by the WEC.

- drive train;
- asynchronous generator;
- PI controller.

In the following paragraphs, the model for each component is presented.

#### A. Drive Train Model

In order to model the drive train, the simple configuration shown in Fig. 5 is chosen [3], [7], [8].

The mechanical equation of turbine and generator side inertia is

$$\begin{aligned} T'_a - T_k &= (J'_a s + D'_a) \Omega_a \\ T_k - T_g &= (J_g s + D_g) \Omega_g \end{aligned} \quad (1)$$

where

- $T'_a$  is the aerodynamic torque referred to the high-speed shaft;
- $J'_a$  and  $D'_a$  are the inertia and friction of rotor side referred to the high shaft, respectively;

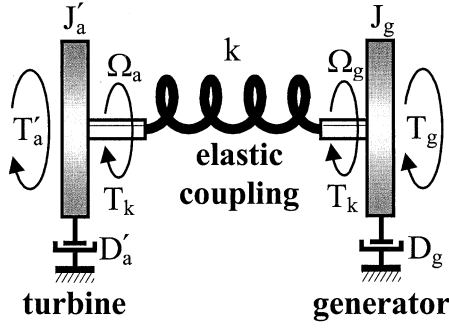

Fig. 5. Drive train model.

- $T_k$  and  $T_g$  are the torque in the flexible coupling and in the electric generator, respectively;
- $J_g$  and  $D_g$  are the inertia and friction of generator side, respectively.

The equation of flexible coupling is

$$T_k = \frac{k}{s}(\Omega_a - \Omega_g) \quad (2)$$

where  $\Omega_a$  and  $\Omega_g$  are the speeds before and after flexible coupling, and  $k$  is the stiffness of coupling.

From (1) and (2), the following equation can be obtained:

$$\Omega_a = \frac{(J_g s^2 + D_g s + k_g)T'_a - kT_g}{P(s)} \quad (3)$$

where

$$P(s) = J_g J'_a s^3 + (J_g D'_a + J'_a D_g) s^2 + [(J_g + J'_a)k + D_g D'_a] s + (D_g + D'_a)k. \quad (4)$$

If the generator is running at an almost constant speed, the frequency of vibrational mode can be approximated by

$$f_r = \frac{1}{2\pi} \sqrt{\frac{k}{J'_a}} \quad (5)$$

whose value for the studied plant (see Table I) is 0.69 Hz

### B. Asynchronous Generator Model

The fluctuations studied in this paper have a low frequency so many electromagnetic transients can be neglected. In this way, a simple first-order model has been used for simulation [7]

$$T_g = \frac{-D_e}{1 + \tau s} (\Omega_s - \Omega_g) \quad (6)$$

where  $\Omega_s$  is the synchronous speed or the network frequency divided by the number of pole pairs of the machine, and  $D_e$  and  $\tau$  are constants.

A well-known sixth-order DQ model is used to evaluate the validity of the model depicted by (6) [9]. As can be seen in Table II and Fig. 6, the parameters and accuracy of the first-order approximation depend on the machine configuration: network-connected or isolated.

### C. PI Controller

Depending on wind speed, the studied WEC has two running modes. In low wind conditions, the blade pitch is adjusted following a previously defined chart, in order to extract as much energy as possible from the wind (see Fig. 7). On the other hand, in high wind conditions, the blade pitch is adjusted to keep the

TABLE I  
DRIVE TRAIN PARAMETERS

$J'_a$	120.64	$J_g$	10.00	$\text{kg}\cdot\text{m}^2$
$D'_a$	0.61	$D_g$	0.61	$\text{N}\cdot\text{m}\cdot\text{s}$
		$k$	2242	$\text{N}\cdot\text{m}/\text{rad}$

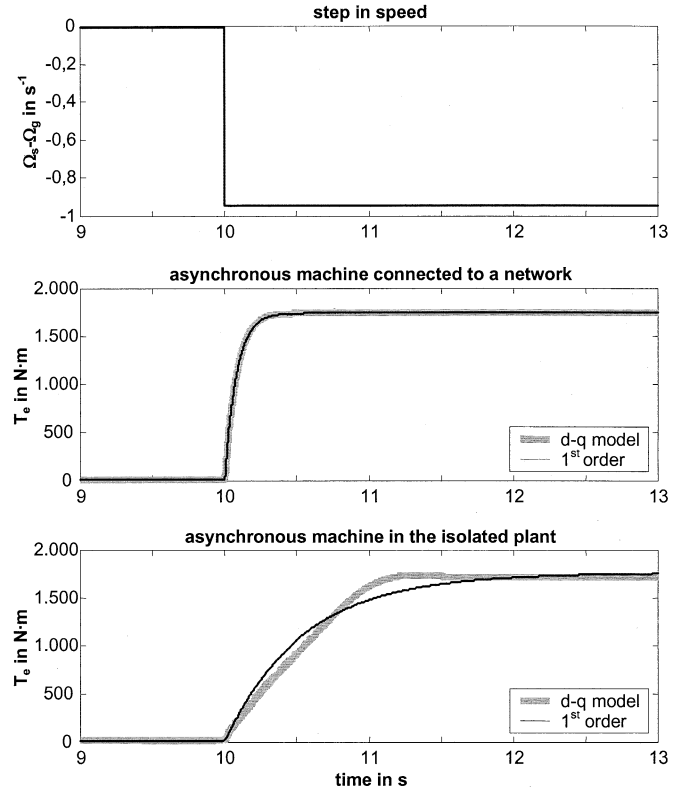

Fig. 6. Step response of an asynchronous machine: comparison between a complete  $d$ - $q$  model and a simple first-order model.

TABLE II  
PARAMETERS OF THE ASYNCHRONOUS GENERATOR MODEL, IN THE ISOLATED AND THE NETWORK-CONNECTED CONFIGURATIONS

	$D_e$ in $\text{N}\cdot\text{m}\cdot\text{s}$	$\tau$ in s
Isolated	1884	0.55
Network-connected	1851	0.08

power (or torque) delivered by the WEC at a reference value (see Fig. 7). In this last situation, pitch variation is done with a PI controller [3], [10]

$$T'_a = k_a k_P \left( 1 + \frac{1}{k_I s} \right) (T_{\text{ref}} - T_g) \quad (7)$$

where  $k_P$  and  $k_I$  are the parameters of PI,  $T_{\text{ref}}$  is the reference value, and  $k_a$  represents the relation between pitch and aerodynamic torque assuming

- the WEC is running at an almost constant rotational speed;
- wind speed is constant at around its nominal value;
- variations in the blade pitch are small.

In order to study the plant, only the PI part of the controller has been modeled because the measured oscillatory behavior has only been detected during high wind conditions.

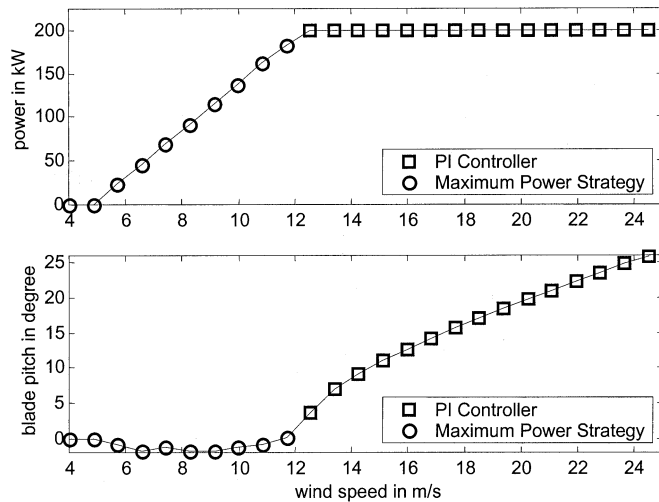

Fig. 7. Strategy for the variation of blade pitch.

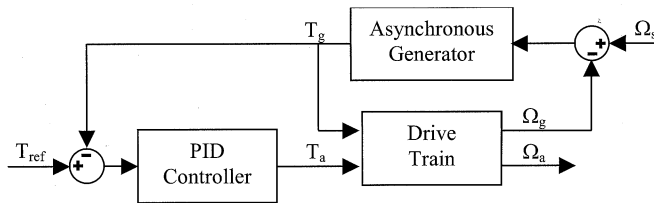

Fig. 8. Block diagram of the WEC.

#### D. WEC Model

The scheme for the complete model can be seen in Fig. 8.

Taking into account (3) and (6), the relationship between aerodynamic torque, generator torque, and synchronous speed without the controller can be written as

$$T_g = \frac{D_e k T'_a - D_e P(s) \Omega_s}{P(s)(1 + \tau s) + (J'_a s^2 + D'_a s + k) D_e}. \quad (8)$$

The frequencies of vibrational modes can be calculated from (8), and their values strongly depend on shaft stiffness, although the same results can be achieved by studying the transfer function between other variables. In Fig. 9, the bode plot for  $T_g/T'_a$  using (8) is shown.

When the controller is included in the model, the whole system can be unstable depending on the controller parameters. In the root locus presented in Fig. 10, the effect of the controller gain can be seen.

In the analyzed plant, when the system starts becoming unstable, it oscillates at a frequency of 0.64 Hz (see Fig. 4). This unstable behavior can be simulated with the following parameters for the controller:  $k_i = 0.75$ ,  $k_p = 0.548$ , and  $k_a = 1.83 \cdot 10^4$  and the results are shown in Figs. 9 and 10. In this case, the oscillation frequency is equal to that observed during the measurements (see Fig. 4) and very close to the frequency of the vibrational mode of the transmission train (5).

The isolated WEC can be compared to a network connected one. For this purpose, only the asynchronous machine parameters, those called  $D_e$  and  $\tau$  in (6), must be changed according to Table II. As a result of simulation, the behavior of the two configurations is quite different [e.g., with the same PI controller

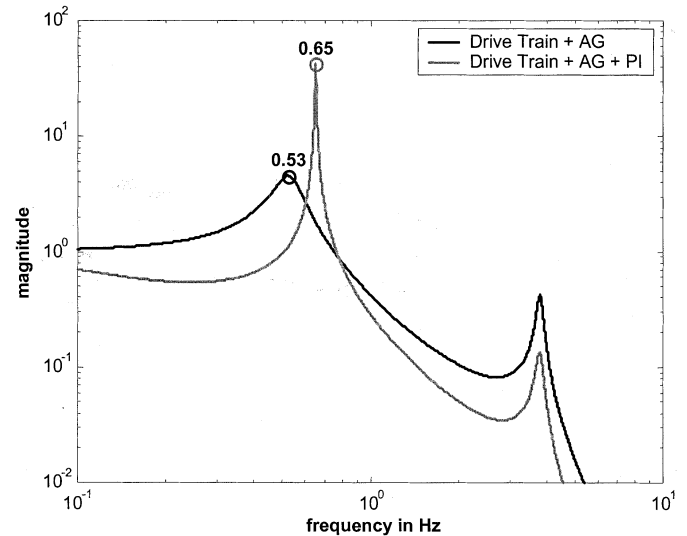

Fig. 9. Bode plot for the  $T_g/T'_a$  transfer function, with and without the PI controller for the isolated WEC.

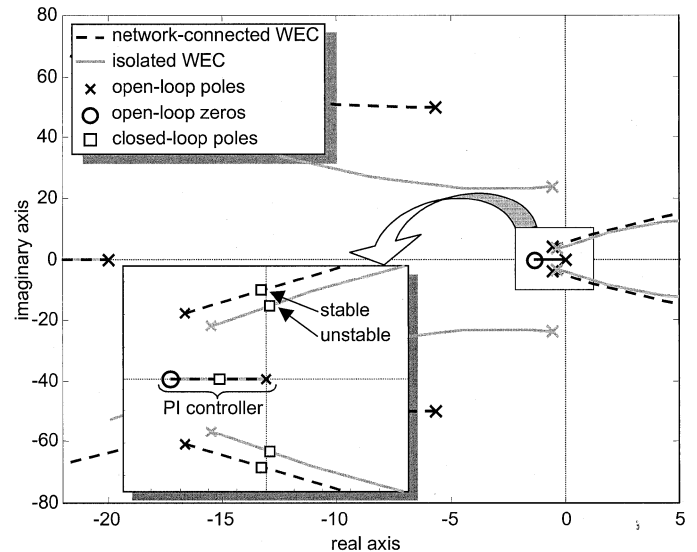

Fig. 10. Root locus for the  $T_g/T'_a$  transfer function for the isolated WEC and the network-connected one.

that resulted unstable in the isolated plant (in Fig. 9)], the system is now stable when it is network-connected, as can be seen in Fig. 10.

#### IV. CONCLUSION

In this paper, a simple WEC model is presented, where it has been noticed that the drive train dominates the dynamic response. The main objective is to simulate the low-frequency power oscillations that can appear in an isolated wind plant. In particular, the model has been used to analyze the unstable behavior measured during the setting of a wind plant in the Canary Islands (Spain).

The results show how the controller parameters can carry the WEC to an unstable situation where the oscillations have the same frequency as measured. Also, the same unstable controller can result in a stable one in a configuration where the WEC is connected to a network.

## ACKNOWLEDGMENT

The authors gratefully acknowledge the cooperation during the campaign of measurements presented in this paper of Centro de Investigación de Energía y Agua – Instituto Tecnológico de Canarias (CIEA–ITC).

## REFERENCES

- [1] T. Thiringer, "Power quality measurements performed on a low-voltage grid equipped with two wind turbines," *IEEE Trans. Energy Conversion*, vol. 11, pp. 601–606, June 1996.
- [2] T. Thiringer and J. A. Dahlberg, "Periodic power pulsations from a three-bladed wind turbine," *IEEE Trans. Energy Conversion*, vol. 16, pp. 128–133, June 2001.
- [3] C. Carrillo, "Análisis y simulación de sistemas eólicos aislados," Ph.D. dissertation (in Spanish), Universidade de Vigo, Spain, 2001.
- [4] A. González *et al.*, "Hybrid wind diesel for a village in the Canary Islands. Development and commissions," in *Proc. Eur. Wind Energy Conf.*, 1993, pp. 326–329.
- [5] I. Cruz *et al.*, "Hybrid wind diesel system for a village in the Canary Islands. Operation results and conclusions," in *Proc. Eur. Union Wind Energy Conf.*, 1996, pp. 398–401.
- [6] S. M. Petersen, "Wind Turbine Test. Vestas V27–225 kW," Risø National Laboratory, Denmark, Risø -M-2861, 1996.
- [7] W. E. Leithead and M. C. M. Rogers, "Options for dive-train design: A dynamic perspective," in *Proc. Eur. Union Wind Energy Conf.*, 1996, pp. 882–885.
- [8] P. Novak, T. Ekelund, I. Jovik, and B. Schmidtbauer, "Modeling and control of variable-speed wind-turbine drive-system dynamics," *IEEE Contr. Syst. Mag.*, vol. 15, pp. 28–38, Aug. 1995.
- [9] P. C. Krause, *Analysis of Electric Machinery*. New York: McGraw-Hill, 1986, p. 164.
- [10] K. Ogata, *Ingeniería de Control Moderna*, México City, México, 1989, p. 164.

**C. Carrillo** was born in 1967. He received the electrical engineering degree from the Universidade de Vigo, Pontevedra, Spain, in 1992, and the Ph.D. degree in electrical engineering in 2001 from ETSEI.

Currently, he is a Lecturer in the Departamento de Enxeñaría Eléctrica at ETSEI. His main fields of research include harmonics, flicker, and wind energy systems.

**A. E. Feijóo** was born in 1965. He received the electrical engineering degree from the Universidade de Santiago de Compostela, Vigo, Spain, and the Ph.D. degree in electrical engineering from the Universidade de Vigo, Pontevedra, Spain.

Currently, he is a Professor in the Departamento de Enxeñaría Eléctrica of the Universidade de Vigo. His current research interests include wind energy and power quality.

**J. Cidrás** (M'92) was born in 1957. He received the electrical engineering degree from the Universidad de Las Palmas de G.C., Las Palmas de Gran Canaria, Spain, and the Ph.D. degree in electrical engineering from the Universidade de Santiago, Vigo, Spain, in 1987.

Currently, he is a Professor in the Departamento de Enxeñaría Eléctrica at ETSEI and Director of the Escola Técnica Superior de Enxeñeiros Industriais of the Universidade de Vigo, Pontevedra, Spain. He leads some investigation projects on wind energy, photovoltaic, and planning of power systems.

**J. González** was born in 1953. He received the electrical engineering and Ph.D. degrees from the Universidad de Las Palmas de G.C., Las Palmas de Gran Canaria, Spain.

Currently, he is a Professor in the Departamento de Ingeniería Electrónica y Automática at the Universidad de Las Palmas. He was also with Canterbury University, Christchurch, New Zealand, working in power system harmonics from 1992 to 1993.